

ULTRACISION® HARMONIC SCALPEL®

Generator 300 System User Manual

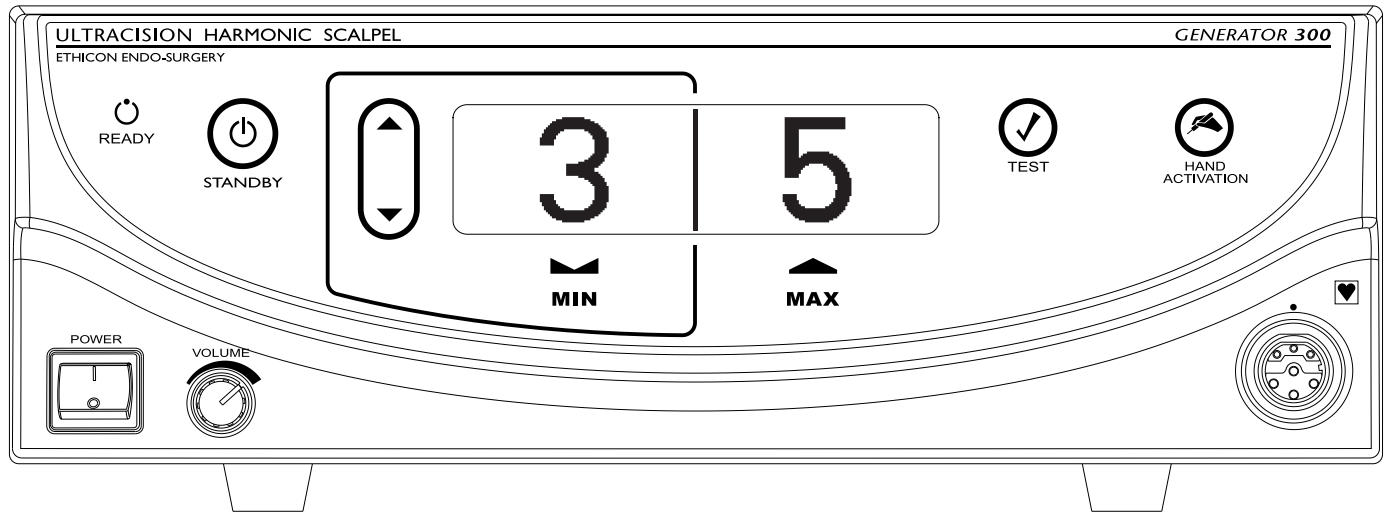

Manuel d'utilisation du Système de Générateur 300

Bedienungsanleitung für das Generator 300 System

Manuale dell'operatore del sistema generatore 300

Manual do utilizador do Sistema Gerador 300

Manual del usuario del sistema generador 300

Gebruikershandleiding generator 300-systeem

Brugermanual til generator 300 system

Generaattorijärjestelmän 300 käyttöopas

Εγχειρίδιο Χρήσης του Συστήματος Γεννήτρια 300

Användarhandledning för generator 300-systemet

Instrukcja obsługi systemu generatora 300

Generátor 300 rendszer Használati útmutató

Uživatelská příručka systému Generator 300

Používateľská príručka pre systém Generator 300

ウルトラシジョン* ハーモニック スカルペル*

ジェネレーター 300 システム添付文書

| | |
|--|-----------|
| Chapter 1 – General Information | 1 |
| Indications | 1 |
| Contraindications | 1 |
| Chapter 2 – Principles of Operation | 3 |
| System Components | 3 |
| <i>Generator 300</i> | 3 |
| <i>Hand Piece</i> | 3 |
| <i>Instrument</i> | 3 |
| Power Levels | 3 |
| Controls, Indicators, and Connections | 4 |
| Unpacking Instructions | 6 |
| Chapter 3 – System Setup and Operation | 7 |
| System Startup | 7 |
| System Operation | 9 |
| System Shutdown | 10 |
| Chapter 4 – Troubleshooting | 11 |
| Audible Indicators and Alarms | 11 |
| Error Codes | 11 |
| Chapter 5 – Cleaning and Disinfection | 17 |
| Generator and Cart Cleaning | 17 |
| Foot Switch Cleaning | 17 |
| Chapter 6 – Safety and Function Testing | 19 |
| Safety Test | 19 |
| Function Test | 19 |
| Calibration | 19 |
| Chapter 7 – Warnings and Precautions | 21 |
| System Warnings and Precautions | 21 |
| Instrument Warnings and Precautions | 22 |
| Chapter 8 – System Specifications | 23 |
| Chapter 9 – Warranty | 25 |
| Chapter 10 – Symbols | 27 |

Please read all information carefully.

Failure to properly follow the instructions may lead to serious surgical consequences.

Important: The ULTRACISION® HARMONIC SCALPEL® Generator 300 System User Manual is designed to provide instructions for use of the ULTRACISION HARMONIC SCALPEL Generator 300, Foot Switch, and Cart (see Chapter 8 – System Specifications - for applicable product codes). This manual is not a reference to surgical techniques.

Note: Refer to package inserts provided separately for information about the Hand Piece, Hand Switching Adaptor, Adaptors, Test Tip and Instruments prior to using the system.

Indications

The ULTRACISION HARMONIC SCALPEL System is indicated for soft tissue incisions when bleeding control and minimal thermal injury are desired. The ULTRACISION HARMONIC SCALPEL System instruments can be used as an adjunct to or substitute for electrosurgery, lasers, and steel scalpels.

Contraindications

- The instruments are not indicated for incising bone.
 - The instruments are not intended for contraceptive tubal occlusion.
-
-

The ULTRACISION HARMONIC SCALPEL System utilizes ultrasonic energy to enable hemostatic cutting and/or coagulation of soft tissue. The system consists of an ultrasonic generator, a foot switch, an optional hand-switching adaptor, a hand piece, and a variety of open and minimally invasive instruments.

Important: The ULTRACISION HARMONIC SCALPEL Generator 300 System User Manual is designed to provide instructions for use of the ULTRACISION HARMONIC SCALPEL Generator 300, Foot Switch, and Cart (see Chapter 8 – System Specifications for applicable product codes). This manual is not a reference to surgical techniques.

Note: Refer to package inserts provided separately for information about the Hand Piece, Hand Switching Adaptor, Adaptors, Test Tip and Instruments prior to using the system.

System Components

Generator 300

The generator supplies the hand piece with electrical energy and facilitates selection of power levels, system monitoring, and system diagnostics.

Power is delivered by activating the foot switch or hand switch.

Hand Piece

The hand piece contains an acoustic transducer that converts the electrical energy supplied by the generator to mechanical motion. The transducer is connected to an amplifier which amplifies the motion produced by the transducer and relays it to the instrument.

Instrument

The mechanical motion from the hand piece advances to the instrument, transmitting ultrasonic energy which enables hemostatic cutting and/or coagulation of tissue.

Note: Throughout this manual “instrument(s)” refers to ULTRACISION HARMONIC SCALPEL blades, ball coagulators, or coagulating shears.

Power Levels

The generator delivers two power levels: minimum (MIN) and maximum (MAX). The minimum power level may be adjusted by the user from Level 1 to 5. The maximum power level is always Level 5. With all instruments except the ball coagulator, use a higher generator power level for greater tissue cutting speed and a lower generator power level for greater coagulation. For the ball coagulator, higher generator power levels will provide greater coagulation. The amount of energy delivered to the tissue and resultant tissue effects are a function of many factors including the power level selected, instrument characteristics, grip force (when applicable), tissue tension, tissue type, pathology, and surgical technique.

Note: Refer to the instruments’ package inserts for additional power level information, including recommended starting power levels.

Controls, Indicators, and Connections

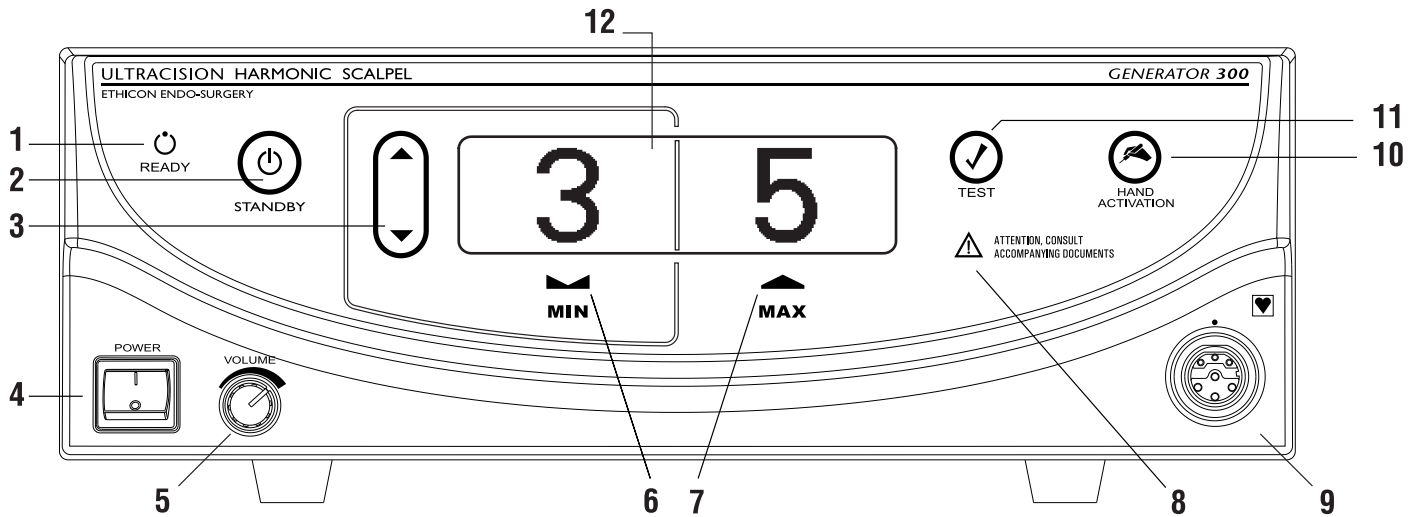

Fig. 2-1 Front Panel

| | | |
|---|---|---|
| 1 | READY | When this indicator is green, the system is ready for activation. |
| 2 | STANDBY | Push this button to toggle between Standby and Ready modes. In Standby mode, this button, and the STANDBY icon, light up and all power is removed from the hand piece. Both the foot switch and hand switch are disabled. Upon power-up, the system defaults to Standby mode enabled. |
| 3 | INCREASE/ DECREASE POWER LEVEL | Push this button to increase or decrease the minimum (MIN) power setting to the desired level (from 1 to 5). The level chosen will be shown on the graphic display. The power level may be adjusted when the generator is in Ready or Standby mode. |
| 4 | POWER | This switch controls the main electrical power to the generator. |
| 5 | VOLUME | Turn this knob to adjust the volume of the activation tones. A tone will sound indicating the volume level selected. |
| 6 | MIN | Indicates the user-settable minimum power level setting. When this power level is activated (by foot switch or hand switch), the “MIN” indicator will flash. The system defaults to “MIN” power level 3. Refer to the instruments’ package inserts for the recommended minimum power level. |
| 7 | MAX | Indicates the maximum power level setting. This setting is always “5”. When this power level is activated (by foot switch or hand switch), the “MAX” indicator will flash. |
| 8 | ALARM INDICATOR | This red indicator appears only if a system alarm occurs in response to a component or generator problem. |

Unpacking Instructions

The ULTRACISION HARMONIC SCALPEL Generator 300 System includes several components that are purchased separately. Upon receiving the ordered components, check for visible shipping damage. If damage is seen, contact your Ethicon Endo-Surgery representative.

System components may include the following parts (for product codes, see Chapter 8 – System Specifications):

Generator 300 – includes the generator, power cord, user manual, and service manual.

Note: The User Manual includes a troubleshooting guide (see back pocket of manual binder). Remove the self-adhesive guide's backing and adhere the guide to the top panel of the generator. Placement guides for the Troubleshooting Guide are found on the generator's top panel.

Foot Switch – includes the foot switch and detachable cable assembly.

Note: The foot switch is required if the system will be used with coagulating shears or instruments without the hand switching adaptor. Since the generator has receptacles for two foot switches, two foot switches may have been shipped.

Cart – the cart is optional. It is designed to hold one ULTRACISION HARMONIC SCALPEL Generator. The cart requires assembly; instructions are included with the cart.

System Startup

Warning: Products manufactured or distributed by companies other than Ethicon Endo-Surgery, Inc. may not be compatible with the ULTRACISION HARMONIC SCALPEL System. Use of such products may lead to unanticipated results and possible injury to the user or patient.

Caution: The ULTRACISION HARMONIC SCALPEL system includes components that are shipped non-sterile (e.g. hand piece, hand switching adaptor, adaptors, and blade wrench). Sterilize products as required before beginning system setup. Refer to individual package inserts for cleaning and sterilization instructions.

- 1 Confirm that the generator power switch is off during setup.
- 2 Secure the generator on its cart or on another suitable fixture. To secure the generator on its cart, place the generator's rubber feet into the corresponding holes on the cart. Push down on the generator's top panel.

Caution: To prevent overheating during use, ensure that the air vents found on the generator's bottom and back panels are not blocked and that they allow adequate clearance from obstructions to allow air to flow freely through the generator enclosure. Avoid placing the generator on a soft surface.

Warning: The ULTRACISION HARMONIC SCALPEL system must be operated within the required ambient operating conditions. Refer to Chapter 8 – System Specifications for requirements.

Caution: Do not simultaneously touch the patient and generator.

- 3 Connect the line cord into the AC inlet located on the generator's rear panel and into an appropriately-grounded outlet. If the power cord is wrapped around the cart handle, it must be completely removed from the cart handle prior to plugging it into the power outlet.

Warning: Verify that the outlet voltage correctly corresponds to the generator's requirements (see Chapter 8 – System Specifications). Connection to an improper power supply may result in damage to the generator and risk of shock or fire hazard.

- 4 a. Attach the foot switch cable to the foot switch:

Note: Although installation of the foot switch is optional when using the hand switching adaptor, installing the foot switch is recommended in case its use is needed during the procedure.

- Confirm that the connector and receptacle are dry and clean.
- Orient the slot on the foot switch cable's larger connector at 12 o'clock.
- Seat the connector in the foot switch receptacle.
- Turn the connector collar clockwise until tight. Ensure the collar is finger-tight to prevent inadvertent activation because of fluid ingress.

b. Connect the foot switch cable's smaller connector to the foot switch receptacle on the rear panel of the generator.

- Confirm that the connector and receptacle are dry and clean.
- Align the red dot on the foot switch 4-pin connector with the red dot on the 4-pin receptacle on the generator back panel.

Note: The generator has two identical foot switch receptacles. If one foot switch is used, either receptacle may be used.

Repeat steps 4a and 4b if a second foot switch will be used.

- 5 Connect the instrument and adaptor (or hand switching adaptor), if required, to the hand piece following instructions in their package inserts.
Note: The hand switching adaptor must be at room temperature to function properly. Do not immerse in water to cool rapidly. After steam sterilization, allow hand switching adaptor to air cool for at least 15 minutes prior to use.
- 6 Connect the hand piece connector to the receptacle on the front panel. Align the white dot on the connector with the white dot on the generator. Ensure the hand piece connector is clean and dry before connecting the hand piece to the generator. Fully insert the hand piece connector to assure complete, proper connection to the generator.
- 7 Turn the generator power switch on and observe the power-up sequence. During power-up, the following indicators on the front panel will briefly illuminate:
 - **READY, STANDBY, MIN, MAX, TEST, ATTENTION, HAND ACTIVATION**

The system will run its start-up sequence and display the software version. An audible tone will sound during the initiation sequence.

Note: The entire power-up initiation sequence should not exceed ten seconds.

If the start-up sequence deviates from the description above, contact qualified service personnel following hospital protocol.

When the initiation sequence is complete, the system will go to Standby. However, if the system detects a faulty generator or incorrect hand piece, a fault will appear on the graphic display (the power levels will not be visible) and an audible alarm will sound. Refer to Chapter 4 – Troubleshooting or the Troubleshooting Guide.

- 8 **Power Levels:** Upon startup, the generator defaults to power level 3 (MIN) and 5 (MAX). The minimum (MIN) power level is user-settable from power levels 1 to 5. To adjust the power level, depress the up/down arrow button to the left of the minimum power level display. Set the power level based on surgeon preference and/or recommendations provided in the instrument's package insert (for more information, see Power Levels section in Chapter 2 – Principles of Operation).
- 9 **Audible tones:** The generator has three activation tone sets from which to choose (the mid-pitch tone is factory set). To choose another tone:
 - a. Switch power off.
 - b. Switch power on. Then immediately depress **and hold** both the STANDBY and HAND ACTIVATION buttons. When the graphic shown in Figure 3-1 appears on the display, release the STANDBY and HAND ACTIVATION buttons.
 - c. While in the Tone Selection mode, the generator will automatically sequence through the available tone pitches. To select a tone, depress any button on the control panel. The generator will return to Standby mode. The tone chosen will be saved until it is changed again by accessing the Tone Selection mode.



Fig. 3-1 Tone Selection Display

Adjust tone volume by turning the knob on the lower left corner of the control panel. A tone will sound to indicate the volume level selected. For safety reasons, the tone may not be disabled.

System Operation

Important: The ULTRACISION HARMONIC SCALPEL Generator 300 System User Manual is designed to provide instructions for use of the ULTRACISION HARMONIC SCALPEL Generator 300, Foot Switch, and Cart (see Chapter 8 – System Specifications - for applicable product codes). This manual is not a reference to surgical techniques.

Note: Refer to package inserts provided separately for information about the Hand Piece, Hand Switching Adaptor, Adaptors, Test Tip and Instruments prior to using the system.

After completing system setup, the system may be operated.

1 Place the generator in Ready mode by depressing the STANDBY button.

2 System check and activation:

Each time the generator is activated after exiting Standby, hold the instrument in the air (if coagulating shears are used, open the clamp arm) and depress the MIN or MAX power level on the foot switch or hand switching adaptor. “TEST IN PROGRESS” will appear on the graphic display and a rapid two-tone pulse will sound while the test is occurring. During this five-second period, a system check is being performed.

- If the system is operating properly, the activation tone corresponding to the power level activated will be heard when the check is complete. Stop activation, position the instrument on tissue, and resume activation.
- If the system is not operating properly, an error code will appear (refer to Chapter 4 – Troubleshooting or the Troubleshooting Guide).

Warning: To avoid user or patient injury, ensure that the instrument is clear of other instruments, drapes, the patient or other objects during the system check. Safety measures (in accordance with hospital protocol) taken in the presence of aerosols should be in effect during the system check.

Note: The foot switch or hand switch must be depressed until the system check is completed. If the switch is released prematurely, the check will reinitiate at the next activation.

Note: The system check will also be performed whenever the hand piece is removed and replaced or TEST is pressed.

Note: The hand activation button on the generator control panel must be illuminated for the hand switches to be active. To deactivate the hand switches, depress the hand activation button (if the hand activation button is not illuminated, hand switches will be inactive).

Note: If the hand switch will not turn off during operation, depress the button corresponding to the power level opposite that being activated to turn it off - an alarm will sound. Press the HAND ACTIVATION button to disable the hand switching adaptor. Place the generator in Standby, and replace the hand switch; or, continue using the foot switch after deactivating the hand switch.

If the foot switch will not turn off during operation, depress the pedal corresponding to the power level opposite that being activated to turn it off - an alarm will sound. Release the pedal to silence the alarm. Place the generator in Standby, and replace the foot switch.

- 3 If the system senses a generator, hand piece, or instrument fault during use, an audible alarm (tone with long pulses) will sound and a visual alarm indicator will appear on the control panel. (Refer to Chapter 4 – Troubleshooting or the Troubleshooting Guide to resolve the problem.)

Warning: Place the generator in Standby mode before removing or replacing an instrument, hand switching adaptor or hand piece or when the system is not in use.

System Shutdown

- 1 Turn the generator power switch off and remove power cord from outlet.
 - 2 Disconnect the hand piece, instrument, and adaptor or hand switching adaptor (if used) and process them as indicated in their respective package inserts.
 - 3 Clean the generator and cart and disinfect the foot switch(es) following hospital protocol (for recommendations, refer to Chapter 5 – Cleaning and Disinfection).
 - 4 Store foot switch(es) on the cart shelves provided. Each shelf will hold one foot switch.
 - 5 Wrap foot switch cable(s) and the power cord on the cart's back handle for storage.
-
-

The Generator 300 System supports a series of alarms and error codes to help in the identification and troubleshooting of component problems. These guides are meant as an adjunct to, but not a substitute for, clinical judgment and observations.

Audible Indicators and Alarms

| Tone | Possible Cause and Corrective Action |
|---|--|
| No tone when system is activated. | <p>Confirm foot switch is fully connected (if hand switch is not being used).</p> <p>Confirm foot switch is not faulty.</p> <p>If hand switch is used, confirm it is connected and not faulty.</p> <p>Confirm hand activation is enabled if hand switching adaptor is being used.</p> |
| Activation (brief pulses) | System is being activated or is in Test mode. System is operating properly. MIN and MAX power have unique tones. |
| Alert (three-tone sequence) | <p>Activation is attempted while generator is in Standby mode. Push the STANDBY button to return the generator to Ready mode.</p> <p>Two or more foot or hand switches are recognized by the generator as being activated simultaneously. Reactivate using only one switch.</p> |
| Constant tone | <p>1) Instrument is in contact with too much tissue. Reduce the amount of tissue in contact with the instrument. If tone persists, carefully remove any tissue that has collected in the distal end of the instrument shaft.</p> <p>2) Hand piece and/or blade fault. Press TEST to identify source of fault.</p> |
| Prolonged solid tone during activation (exceeds 10 seconds) | Hand piece and/or blade fault. Press TEST to identify source of fault. |
| Alarm (two-tone sequence) | <p>A component or system problem has occurred. Refer to the Error Codes section in this chapter or the Troubleshooting Guide.</p> <p>Note: This alarm will activate for three seconds, then will silence itself for 30 seconds. This cycle will continue until the error is resolved or the main power switch is turned off.</p> |

Error Codes

The generator will recognize specific faults in five areas: generator, hand piece, instrument, foot switch or hand switch. When a fault is identified, an alarm will sound, the alarm indicator will appear on the generator control panel, and the source of the problem will appear on the graphic display (the power levels will not be displayed). See Fig. 4-1 below for an example. Follow the procedures outlined below (or in the Troubleshooting Guide) to resolve the problem.

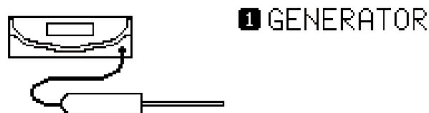

Fig. 4-1 Alarm Indicator (example)

Error Code 1: Generator

Error Code 1 indicates either there is a functional problem with the generator or the front panel button(s) were activated during power-up sequence.

Cycle the power OFF then ON. If error persists, power off system and contact service.

Error Code 2: Generator Temperature

Error Code 2 indicates that the generator is overheating.

- 1** Power off system. Remove any obstructions blocking the air vents on the generator's bottom and back panels. If there is no apparent obstruction or external heat source, contact service.
- 2** Power on the system and wait for up to 30 minutes for generator error to clear.
- 3** If error code persists, contact service.

Error Code 3: Hand Piece

Error Code 3 indicates a problem with the hand piece.

- 1** Confirm that the hand piece connector is fully inserted and properly oriented – white dot on handpiece is aligned with white dot on front panel. If the error code does not clear within three seconds after the hand piece is properly connected, press TEST.
- 2** The instrument may not be tightened properly or tissue may have collected in the distal end of the instrument shaft. Tighten instrument using blade wrench and carefully remove tissue from distal end of instrument sheath. Press STANDBY to clear error code and return to Ready mode. Activate system. If the pre-run test is running, ensure instrument is in air. If using shears, ensure jaws are open and not in contact with any objects during pre-run test.

Note: Inspect the blade wrench hub for cracks or wear before use. If damage is seen, replace the blade wrench. Before use after autoclaving, cool the blade wrench at room temperature for at least 45 minutes or soak it in room temperature sterile water for 5 minutes.

- 3** If the error persists, install a test tip to isolate the problem. Press TEST button.
 - If system indicates a hand piece error, hand piece is bad or test tip is bad. Replace hand piece or install a new test tip and press TEST.
 - If no error occurs with test tip attached, replace instrument.
- 4** Press STANDBY to return to Ready mode. Activate system.

Error Code 4: Hand Piece Temperature

Error Code 4 indicates that the hand piece has exceeded its specified operating temperature. For immediate recovery, use another hand piece; or, follow the steps below to determine the cause of the error condition and alternate recovery methods.

The following are possible causes of an increase in hand piece temperature. To correct, complete the appropriate steps below and *allow the hand piece to cool before resuming operation.*

- 1 The hand piece is still warm from recent steam sterilization. Allow the hand piece to cool at room temperature for at least 45 minutes or soak it in room-temperature sterile water for 5 minutes before resuming operation.

Note: The hand switching adaptor (HSA07) should not be submerged for rapid cooling purposes. This may render the hand switching adaptor inoperable for an extended period of time. After steam sterilization, allow the hand switching adaptor to air cool at least 15 minutes prior to use.

- 2 The instrument may not be tightened properly or tissue may have collected in the distal end of the instrument shaft. Tighten instrument using blade wrench and carefully remove tissue from distal end of instrument sheath. Press STANDBY to clear error code and return to Ready mode. Activate system. If the pre-run test is running, ensure instrument is in air. If using shears, ensure jaws are open and not in contact with any objects during pre-run test.

Note: Inspect the blade wrench hub for cracks or wear before use. If damage is seen, replace the blade wrench. Before use after autoclaving, cool the blade wrench at room temperature for at least 45 minutes or soak it in room temperature sterile water for 5 minutes.

- 3 If the error persists, install a test tip to isolate the problem. Press TEST button.
 - If system indicates a hand piece error, hand piece is bad or test tip is bad. Replace hand piece or install a new test tip and press TEST.
 - If no error occurs with test tip attached, replace instrument.
- 4 Press STANDBY to return to Ready mode. Activate system.
- 5 If the hand piece does not show evidence of overheating and troubleshooting steps 1-4 above do not appear to resolve the problem, perform the following:
 - a. Leave the hand piece at room temperature for 24 hours or more.
 - b. Remove any test tip or instrument from the hand piece.
 - c. With the generator turned off, plug the hand piece into any Generator 300.
 - d. Power up the generator in Biomed mode.
 - Press and hold down the STANDBY button and down arrow key.
 - Wait for a steady display – approximately 10 seconds.
 - If a “Generator” error occurs, then one of the buttons was not properly held down. If this happens, repeat the power up procedure in Biomed mode.

- e. Record the “XDUCER CAPACITANCE” value.
 - Press the STANDBY button, if necessary, until it illuminates.
 - Use the increase/decrease arrow keys to get to “Page 2 of 21”.
 - Record the number opposite “XDUCER CAPACITANCE”.
 - Press the STANDBY button until the Standby light turns off.
 - Leave the hand piece plugged into the generator. Do not remove hand piece during entire procedure. Do not activate the MIN or MAX activation buttons on the foot switch or hand switch if either is attached.
 - After a period of time that exceeds 30 or more minutes, press the STANDBY button until the STANDBY light is illuminated.
 - Again, read the “XDUCER CAPACITANCE” on Page 2 of 21.
 - If the number has changed, the update was successful.
 - If the number has not changed, then this update attempt did not succeed. Power down the generator and repeat Step 5.

Note: As the hand piece ages, the generator performs measurements and updates a key hand piece parameter. This function is performed when the internal temperature of the hand piece is stable at room temperature. Certain usage patterns may prevent this update from occurring and subsequently make the hand piece diagnostics more sensitive to temperature. The steps above will cause an update of the hand piece parameter and return the system to designed sensitivity.

Warning: To avoid user or patient injury, ensure that the instrument is clear of other instruments, drapes, the patient or other objects before pressing TEST. Safety measures (in accordance with hospital protocol) taken in the presence of aerosols should be in effect while in Test mode.

Note: Do not run the Test mode while an electrosurgical generator is being activated in the room. Interference from the electrosurgical generator may affect test results.

Error Code 5: Instrument

Error Code 5 indicates a problem with the instrument.

- I The instrument may not be tightened properly or tissue may have collected in the distal end of the instrument shaft. Tighten instrument using blade wrench and carefully remove tissue from distal end of instrument sheath. Press STANDBY to clear error code and return to Ready mode. Activate system. If the pre-run test is running, ensure instrument is in air. If using shears, ensure jaws are open and not in contact with any objects during pre-run test.

Note: Inspect the blade wrench hub for cracks or wear before use. If damage is seen, replace the blade wrench. Before use after autoclaving, cool the blade wrench at room temperature for at least 45 minutes or soak it in room temperature sterile water for 5 minutes.

- 2 If the error persists, install a test tip to isolate the problem. Press TEST button.
 - If system indicates a hand piece error, hand piece is bad or test tip is bad. Replace hand piece or install a new test tip and press TEST.
 - If no error occurs with test tip attached, replace instrument.
- 3 Press STANDBY to return to Ready mode. Activate system.

Note: Inspect the blade wrench hub for cracks or wear before use. If damage is seen, replace the blade wrench. Before use after autoclaving, cool the blade wrench at room temperature for at least 45 minutes or soak it in room temperature sterile water for 5 minutes.

Warning: To avoid user or patient injury, ensure that the instrument is clear of other instruments, drapes, the patient, or other interference before pressing TEST. Safety measures (in accordance with hospital protocol) taken in the presence of aerosols should be in effect while in Test mode.

Note: Do not run the Test mode while an electrosurgical generator is being activated in the room. Interference from the electrosurgical generator may affect test results.

Error Code 6: Foot Switch

Error Code 6 indicates a foot switch pedal is stuck in the ON position. Confirm generator receptacle, foot switch receptacles and cable connectors are clean and dry or replace the foot switch.

Note: If the error persists, replace foot switch.

Error Code 7: Hand Switch

Error Code 7 indicates the hand switch is stuck in the ON position. Confirm contacts in the distal end of hand piece and in the proximal end of the hand switching adaptor are dry or replace the hand switching adaptor.

Note: If the error persists, replace hand switch.

Generator and Cart Cleaning

Clean generator and cart following hospital protocol. Before cleaning, turn the generator main power off and unplug the power cord from the grounded electrical outlet.

Warning: Spilling or spraying fluids on or into the generator or immersing the generator may result in damage to the generator and risk of shock or fire hazard.

Proceed with cleaning as follows:

- 1 Prepare a neutral pH detergent or neutral pH enzymatic detergent according to the detergent manufacturer's directions.
- 2 Use a soft, clean cloth lightly moistened with the cleaning solution to manually clean all surfaces (including the generator's display).
- 3 Rinse thoroughly using a soft, clean cloth lightly moistened with warm tap water.
- 4 Dry with a clean, soft cloth.

Foot Switch Cleaning

The foot switch and cable should be cleaned after each use as follows:

- 1 Disconnect the foot switch from the generator.
- 2 Prepare a neutral pH enzymatic detergent according to the detergent manufacturer's directions.
- 3 With the cable securely attached to the foot switch, soak the foot switch and cable in the detergent solution for two minutes.

Note: Keep the foot switch cable connector that connects to the generator dry at all times to prevent inadvertent activation.

- 4 After soaking, use a soft-bristled brush to manually clean the foot switch and cable keeping them immersed in the detergent solution.
 - 5 Thoroughly rinse the foot switch and cable – with the cable securely attached to the foot switch – with warm, running tap water for at least one minute.
 - 6 Dry all surfaces with a clean, soft cloth.
-
-

Test hand piece, generator, and foot switch for safety and function according to hospital protocol. Refer to individual package inserts for safety and function testing for other multi-patient use components.

Safety Test

Generator: A qualified hospital technician should perform a leakage current test.

Foot Switch: Examine the foot pedals, cable connectors, and cable for cracks or other damage and replace if damaged.

Other Components: Examine the components by following the instructions in their individual package inserts.

Function Test

- 1 Perform complete instrument preparation and hand piece attachment as described in Chapter 3 – System Setup and Operation. Attach the test tip rather than an instrument.
- 2 Verify that the orange STANDBY indicator is illuminated.
- 3 Push the STANDBY button to leave Standby mode and enter Ready mode.
- 4 Verify that the green READY indicator is illuminated.
- 5 Verify that MIN Power Level 3 and MAX Power Level 5 are displayed.
- 6 Push the Increase and Decrease Power Level button up and down to confirm the MIN Power Level changes from 1 to 5.
- 7 Turn the generator off. Wait five seconds, then turn the generator back on. Wait ten seconds, then confirm MIN Power Level 3 and MAX Power Level 5 are displayed. Confirm the generator is not being activated unexpectedly.
- 8 Place the generator in Ready mode by depressing the STANDBY button. Hold the hand piece so that the distal portion is in the air and step on the MAX foot switch pedal (before activation begins, a five-second system check will be performed – “TEST IN PROGRESS” will appear on the display). Verify that the MAX Power Level indicator on the control panel flashes and that the MAX activation tone is heard.

Warning: To avoid user injury, ensure that the test tip is clear of tissue, other instruments, or other objects before activating the system.

- 9 Hold the hand piece so that the distal portion is in air and step on the MIN foot switch pedal. Verify that the MIN Power Level indicator on the control panel flashes and that the MIN activation tone is heard.

Warning: To avoid user injury, ensure that the test tip is clear of tissue, other instruments, or other objects before activating the system.

Calibration

Refer to the Generator 300 System Service Manual for system calibration information.

System Warnings and Precautions

- Minimally invasive procedures should be performed only by persons having adequate training and familiarity with minimally invasive techniques. Consult medical literature relative to techniques, complications, and hazards prior to performance of any minimally invasive procedure.
- Minimally invasive instruments may vary from manufacturer to manufacturer. When minimally invasive instruments and accessories from different manufacturers are employed together in a procedure, verify compatibility prior to initiation of the procedure.
- A thorough understanding of the principles and techniques involved in laser, electrosurgical, and ultrasonic procedures is essential to avoid shock and burn hazards to both patient and medical personnel and damage to the device or other medical instruments. Ensure that electrical insulation or grounding is not compromised. Do not immerse electrosurgical instruments in liquid unless the instruments are designed and labeled to be immersed.
- Safe and effective ultrasonic surgery is dependent not only upon equipment design, but also, to a large extent, upon factors under control of the operator. It is important that the instructions supplied with this equipment be read, understood, and followed in order to enhance safety and effectiveness.
- As with all energy sources (Electrosurgery, Laser, or Ultrasound), there are concerns about the carcinogenic and infectious potential of the by-products, such as tissue smoke plume and aerosols. Appropriate measures such as protective eyewear, filtration masks, and effective smoke evacuation equipment should be used in both open and laparoscopic procedures.
- To avoid user or patient injury in the event that accidental activation occurs, the ULTRACISION HARMONIC SCALPEL instrument blades should not be in contact with the patient, drapes, or flammable materials while not in use. During prolonged activation in tissue, the instrument blade, clamp arm and distal end of the shaft may become hot. Avoid unintended blade contact with tissue, drapes, surgical gowns, or other unintended sites after activation.
- To avoid user or patient injury, the ULTRACISION HARMONIC SCALPEL Generator should not be used prior to biomedical evaluation if it shows signs of damage or is suspected of being dropped or having fluids spilled on it.
- After removing the instrument, examine the tissue for hemostasis. If hemostasis is not present, appropriate techniques should be used to achieve hemostasis.
- Products manufactured or distributed by companies other than Ethicon Endo-Surgery, Inc. may not be compatible with the ULTRACISION HARMONIC SCALPEL system. Use of such products may lead to unanticipated results and possible injury to the user or patient.
- The ULTRACISION HARMONIC SCALPEL system, including the hand piece, is not Magnetic Resonance safe and is not Magnetic Resonance compatible.
- To reduce the risk of interference, electrosurgical systems and the ULTRACISION HARMONIC SCALPEL system should be plugged into separate electrical power circuits. Locate the ULTRACISION HARMONIC SCALPEL system, including the hand piece cable, at least 3 ft. (approximately 1 m) from electrosurgical systems and their hand piece (e.g., pencil) cables.
- Equipment not suitable for use in the presence of a flammable anesthetic mixture with air or with oxygen or nitrous oxide. It is possible to create sparks by hitting other metal instruments. Sparks may ignite flammable gases such as bowel gas.
- The ULTRACISION HARMONIC SCALPEL system must be operated within the required ambient operating conditions. Refer to Chapter 8 – System Specifications for requirements.
- To prevent overheating during use, ensure that the air vents found on the generator's bottom and back panels are not blocked and that they allow adequate clearance from obstructions to allow air to flow freely through the generator enclosure. Avoid placing the generator on a soft surface.
- Verify that the outlet voltage correctly corresponds to the generator's requirements (see Chapter 8 – System Specifications). Connection to an improper power supply may result in damage to the generator and risk of shock or fire hazard.
- The ULTRACISION HARMONIC SCALPEL system includes components that are shipped non-sterile (e.g. hand piece, hand switching adaptor, adaptors, and blade wrench). Sterilize products as required before beginning system setup. Refer to individual package inserts for cleaning and sterilization instructions.
- To avoid user or patient injury, ensure that the instrument is clear of other instruments, drapes, the patient, or other objects before pressing TEST and during the system check. Safety measures (in accordance with hospital protocol) taken in the presence of aerosols should be in effect during the system check and while in Test mode.

- To avoid user injury, ensure that the test tip is clear of tissue, other instruments, or other objects before activating the system.
- Do not simultaneously touch the patient and generator.
- Place the generator in the Standby mode before removing or replacing an instrument, hand switching adaptor or hand piece or when system is not in use.
- Spilling or spraying fluids on or into the generator or immersing the generator may result in damage to the generator and risk of shock or fire hazard.
- In case of system failure, ensure the availability of the appropriate backup equipment relevant to the specific procedure.

Instrument Warnings and Precautions

Blades

All blades have an intermittent operation of 15 second on/off intervals, unless the duty cycle is explicitly specified otherwise in the individual instrument package inserts.

Coagulating Shears

During prolonged activation in tissue, the instrument blade, clamp arm, and the distal 7 cm of the shaft may become hot. Avoid unintended contact with tissue, drapes, surgical gowns, or other unintended sites at all times.

Note: Refer to individual package inserts for additional warnings and precautions.

Product Codes**Required Components for System Operation:**

GEN04: Generator 300

HP054/HP055: Hand Piece (includes HST02 Test Tip and TLB01 Blade Wrench)¹**Instruments and Adaptors:**

Contact your Ethicon Endo-Surgery representative for information about instruments available for use with this system. Some instruments may require use of an adaptor.

Optional Components:FSW01: Foot Switch²HSA07: Hand Switch^{1,2}

CRT01: Cart

¹ Refer to separate product insert supplied with this component.² At a minimum, either the foot switch or the hand switch is required to operate the generator. When the hand switch is used, availability of the foot switch is recommended.**Degree of Protection Against Electric Shock**

Type CF Applied Part

Class of Protection Against Electric Shock

Class I

Safety Standards

EN 60601-1

Degree of Protection Against Harmful Ingress of Water

Generator: Ordinary equipment
Footswitch: IPX8

Safety Classification

UL 2601-1
CSA C22.2 601.1
EN 60601-1

Mains Input

Voltage: 100-240 VAC
Frequency: 50/60 Hz
Current Consumption: 3 amp

Ambient Operating Conditions

Temperature 18°C to 23°C
Humidity: 10-90% non-condensing
Atmospheric Pressure Range: 700hPa-1060hPa

Transport and Storage Conditions

Temperature: -35°C to +54°C
Humidity: 10-95% non-condensing
Atmospheric Pressure Range: 700hPa-1060hPa

| | |
|----------------------------|---|
| Date of Manufacture | <p>The date of manufacture may be determined by viewing the serial number on the rear panel of the generator. The fourth and fifth characters indicate the year of manufacture as follows:</p> <p>GN401 = year 2001 GN402 = year 2002 GN403 = year 2003 GN404 = year 2004 GN405 = year 2005</p> |
| Power Cord | <p>North American removable power cord set with the following characteristics:</p> <p>Plug Style: NEMA 5-15 (clear) North American Hospital Grade Receptacle: IEC 60320 C13 with straight non-angled cord entry Cord Length: 4.6 meters nominal Current Rating: 13A Voltage Rating: 125 VAC minimum Wiring Code: North American Cordage Description: SJT (UL) or SJT (CSA) Conductors: 16 AWG 3C Agency Approvals Required: UL and CSA</p> <p>International removable power cord set with the following characteristics:</p> <p>Plug Style: as needed by particular country requirements Receptacle: IEC 60320 C13 with straight non-angled cord entry Cord Length: 2.44 - 4.6 meters nominal Current Rating: 10A Minimum conductor size cross-sectional area: 1.0mm² copper Voltage Rating: 250 VAC minimum Wiring: international Cordage Type: HAR Item to have certification by at least one of the following agencies: VDE, ASTA, SEMKO, KEMA, LCIE, DFT, IMQ, SEV</p> |
| Duty Cycle | <p>Duty Cycle is determined by hand piece and instrument in use. For duty cycle information, refer to applicable instrument(s) and hand piece inserts and/or Chapter 7 –Warnings and Precautions.</p> |
| Weight (unpacked) | <p>Generator: 7.48 kg nominal</p> <p>Cart: 42.0 kg nominal</p> |
| Overall Dimensions | <p>Generator 300 (HxWxD): 5.3" (13 cm) x 14.5" (37 cm) x 15.2" (39 cm)</p> <p>Cart (HxWxD): 37.3" (95 cm) x 17.7" (45 cm) x 27.6" (70 cm), including handle</p> |
| Disposal | <p>Some internal components of the generator, foot switch and foot switch cable contain lead. Disposal should be performed according to local requirements and regulations.</p> |

This warranty and the rights and obligations hereunder shall be construed under and governed by the laws of the State of Ohio, U.S.A.















Ethicon Endo-Surgery, Inc. warrants this product to be free from defects in material and workmanship under normal use and preventive maintenance for the respective warranty period shown below. Ethicon Endo-Surgery's obligation under this warranty is limited to the repair or replacement, at its option, of any product, or part thereof, which has been returned to Ethicon Endo-Surgery, Inc. or its Distributor within the applicable time period shown below and which examination disclosed, to Ethicon Endo-Surgery's satisfaction, to be defective. This warranty does not apply to any product, or part thereof, that has been: (1) adversely affected due to use with devices manufactured or distributed by parties not authorized by Ethicon Endo-Surgery, Inc. (2) repaired or altered outside Ethicon Endo-Surgery's factory in a way so as to, in Ethicon Endo-Surgery's judgement, affect its stability or reliability, (3) subjected to improper use, negligence or accident, or (4) used other than in accordance with the design and use parameters, instructions and guidelines for the product or with functional, operational or environmental standards for similar products generally accepted in the industry.















Ethicon Endo-Surgery's products are warranted for the following periods after delivery to the original purchaser:

| | |
|--------------------------|----------------------------------|
| Hand Pieces | Nine (9) Months, Parts and Labor |
| Generators | One (1) Year, Parts and Labor |
| Carts | One (1) Year, Parts and Labor |
| Foot Switches and Cables | One (1) Year, Parts and Labor |
| Sterilization Tray | One (1) Year, Parts and Labor |

UNLESS SUPERCEDED BY APPLICABLE LOCAL LAW, THIS WARRANTY IS IN LIEU OF ALL OTHER WARRANTIES, EXPRESS OR IMPLIED, INCLUDING THE WARRANTIES OF MERCHANTABILITY AND FITNESS FOR A PARTICULAR PURPOSE, AND OF ALL OTHER OBLIGATIONS OR LIABILITIES ON THE PART OF ETHICON ENDO-SURGERY, INC. AND IS A PURCHASER'S EXCLUSIVE REMEDY. IN NO EVENT SHALL ETHICON ENDO-SURGERY, INC. BE LIABLE FOR SPECIAL, INCIDENTAL OR CONSEQUENTIAL DAMAGES INCLUDING, WITHOUT LIMITATION, DAMAGES RESULTING FROM LOSS OF USE, PROFITS, BUSINESS OR GOODWILL, OTHER THAN AS EXPRESSLY PROVIDED BY A SPECIFIC LAW. Ethicon Endo-Surgery, Inc. neither assumes nor authorizes any other person to assume for it any other liability in connection with the sale or use of any of Ethicon Endo-Surgery Inc. products. There are no warranties that extend beyond the terms hereof.

Ethicon Endo-Surgery, Inc. reserves the right to make changes to products built and/or sold by them at any time without incurring any obligation to make the same or similar changes on products previously built and/or sold by them.

| | |
|---|---|
|  | On |
|  | Off |
|  | Type CF Applied Part |
|  | Lot |
|  | Temperature |
|  | Relative Humidity |
|  | Attention - Consult Accompanying Documents/See Instructions For Use |
|  | Non-Sterile |
|  | Date of Manufacture |
|  | Fragile |
|  | This end up |
|  | Keep dry |
|  | Increase/Decrease |
|  | Serial Number |
|  | Equipotential |

| | |
|---|---|
|  | Fuse |
|  | Safe working load |
|  | Test |
|  | Hand Activation |
|  | Volume |
|  | Minimum |
|  | Maximum |
|  | Ready |
|  | Standby |
|  | Reorder Number |
|  | Caution: Federal (USA) law restricts this device to sale by or on the order of a physician. |
|  | ON/OFF Time for Intermittent Operation. Refer to the individual package insert and/or Chapter 7 – Warnings and Precautions for additional specifications. |
|  | Foot switch |
|  | Category AP (Anaesthetic Proof) Equipment |

| | |
|---|---|
|  | Manufacturer |
|  | Authorized Representative in the European Community |

